

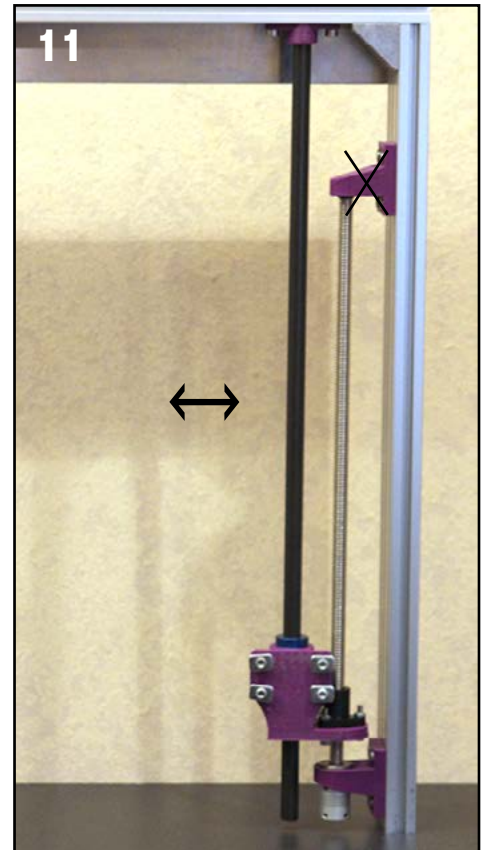

## Gantry assembly (z-axis)

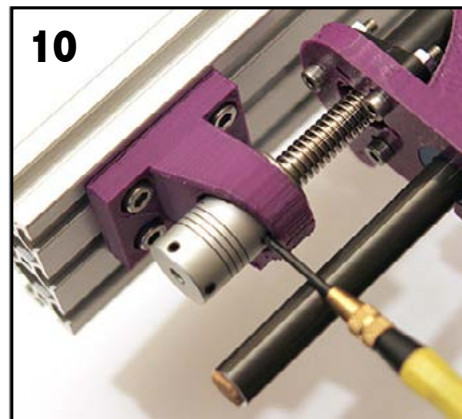

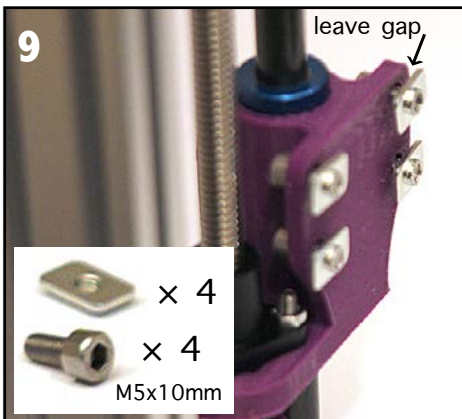
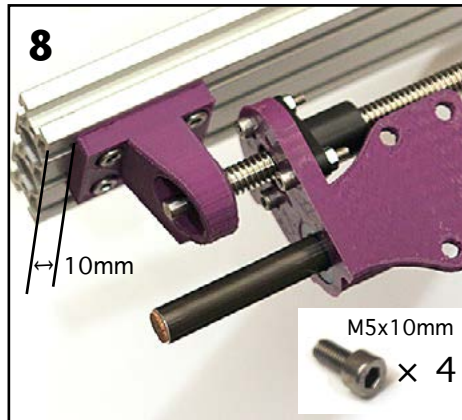
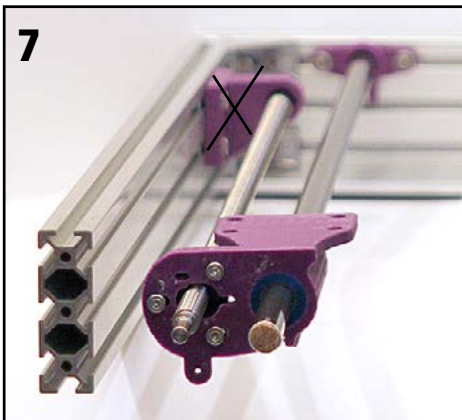
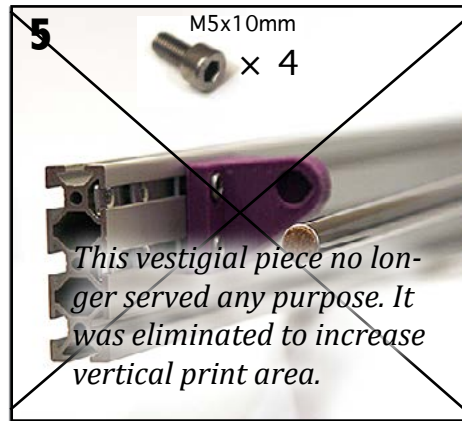
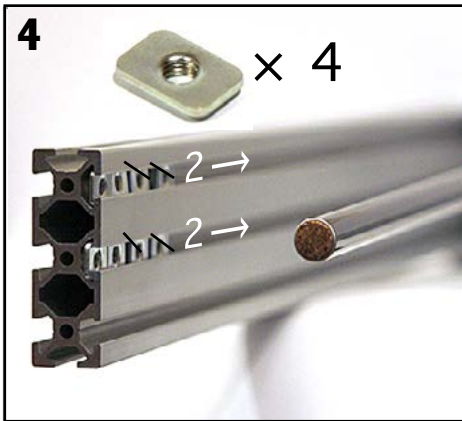
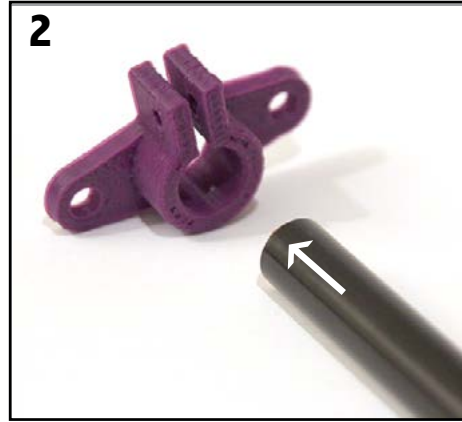

Trinity Labs

# Alminatus TrinityOne

## Extruder assembly (x-axis) and mounting gantry

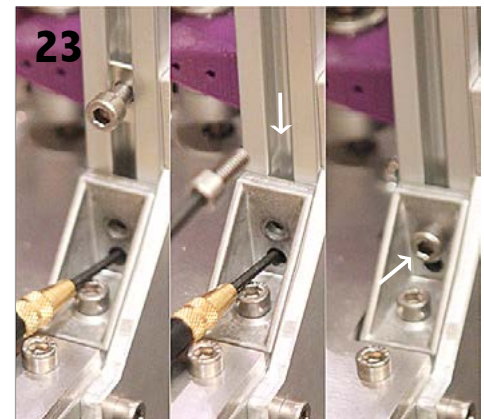
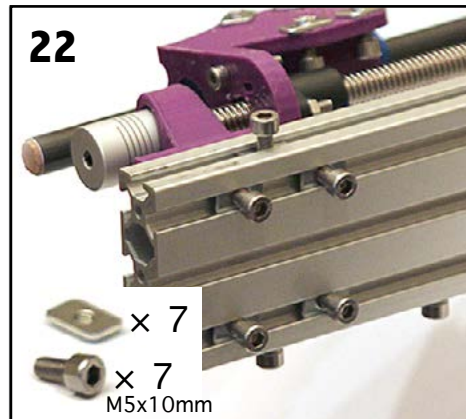
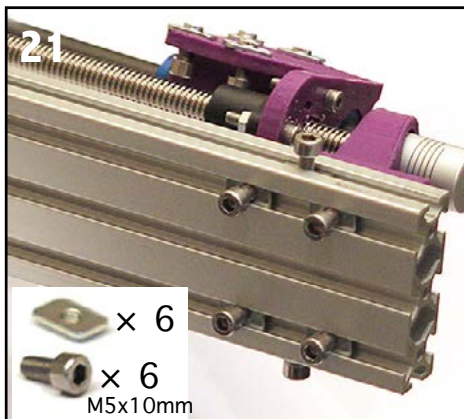
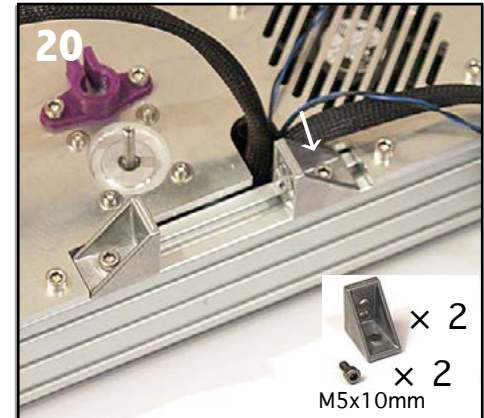
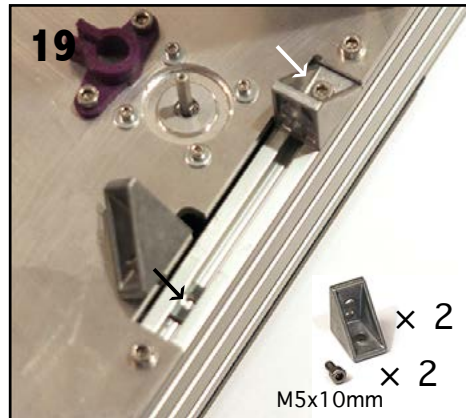
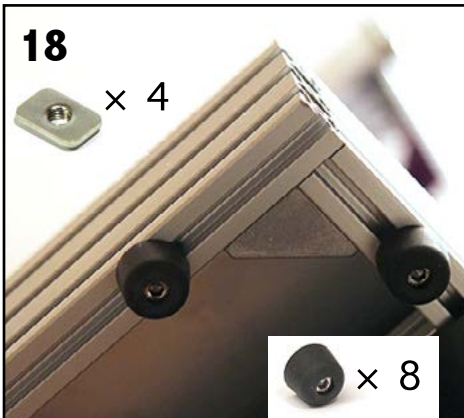
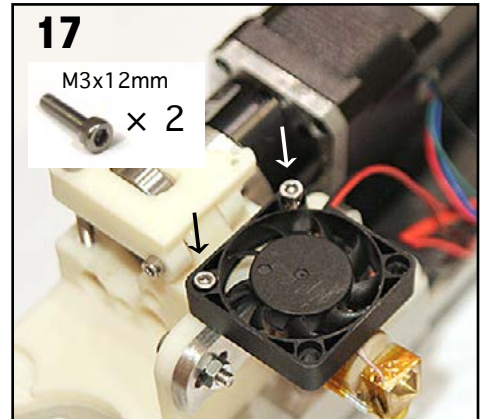
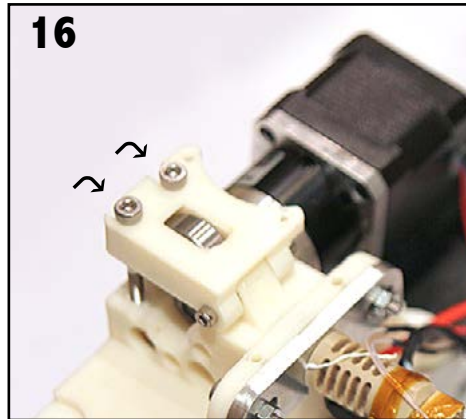
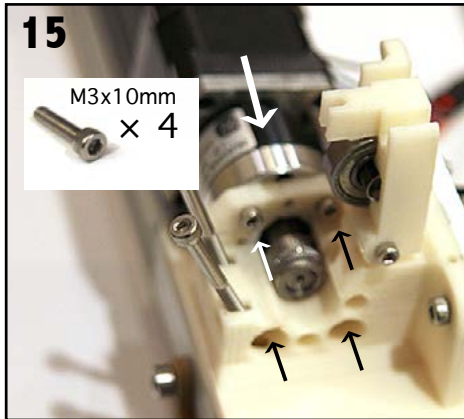
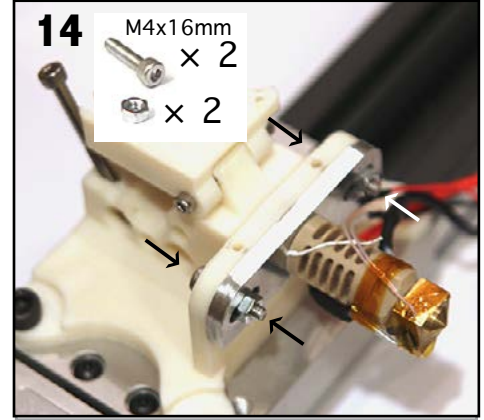
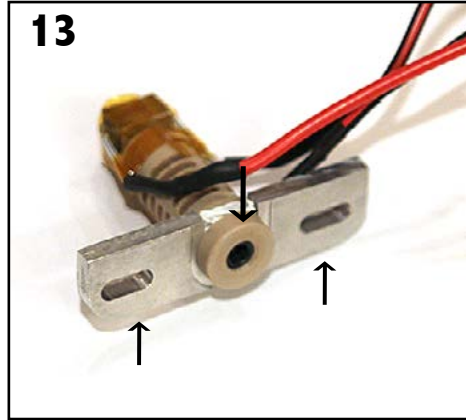
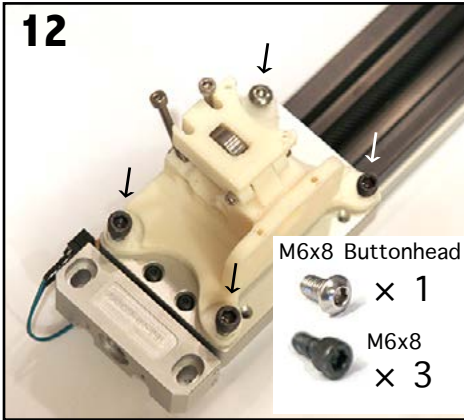



Trinity Labs

# Alminatus TrinityOne

## Mounting gantry and z-axis plate

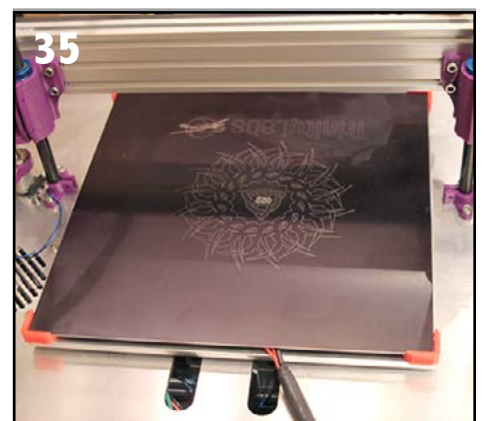
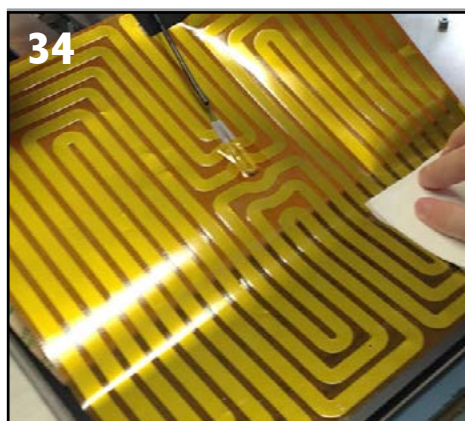
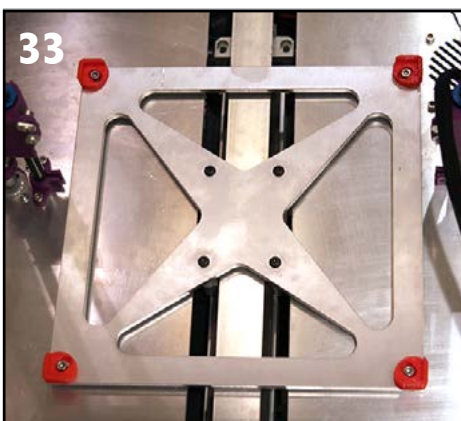
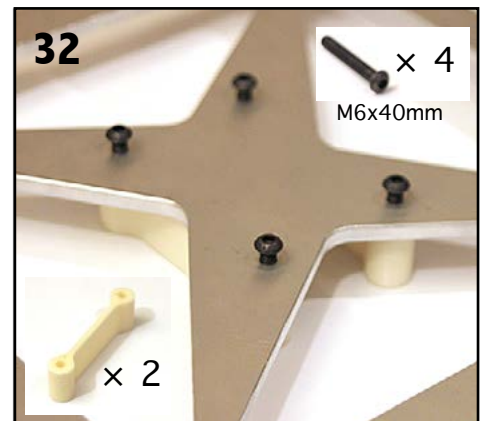
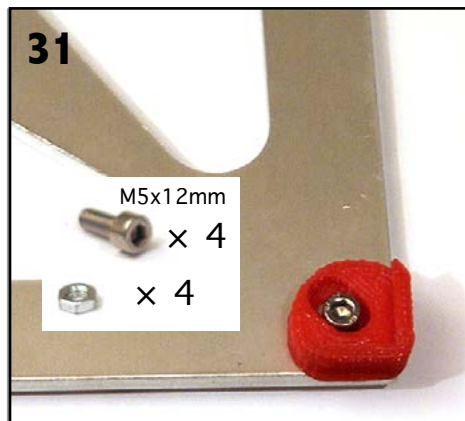
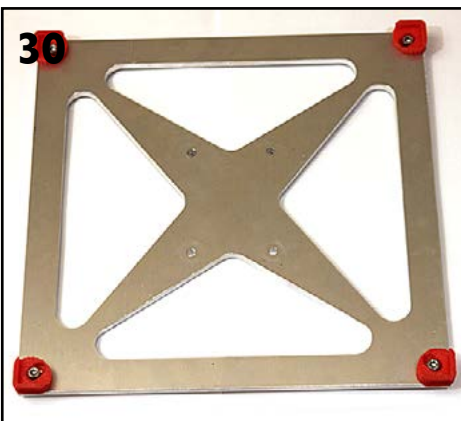
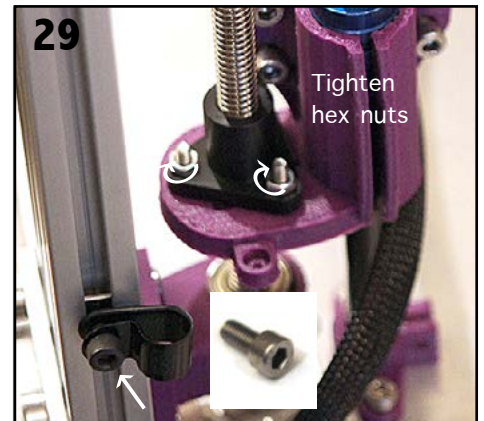
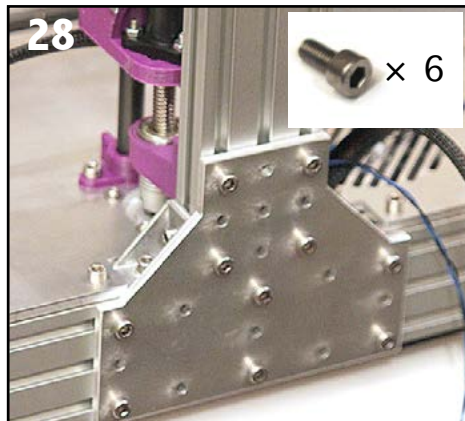
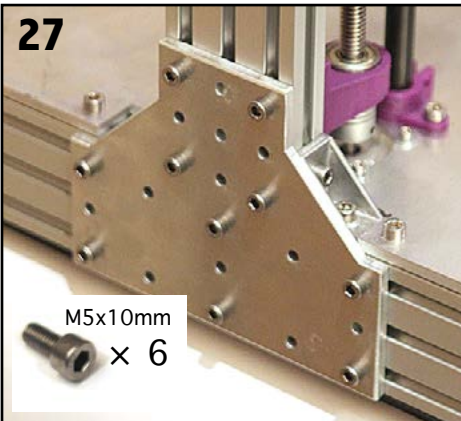
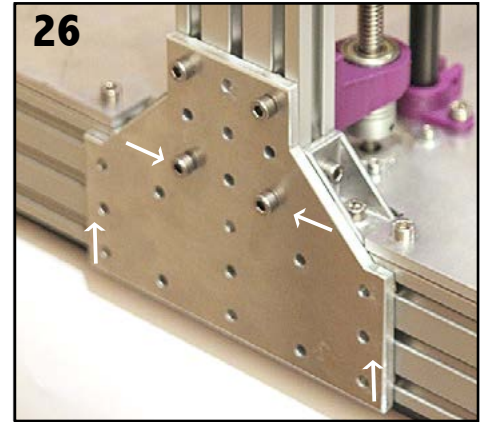
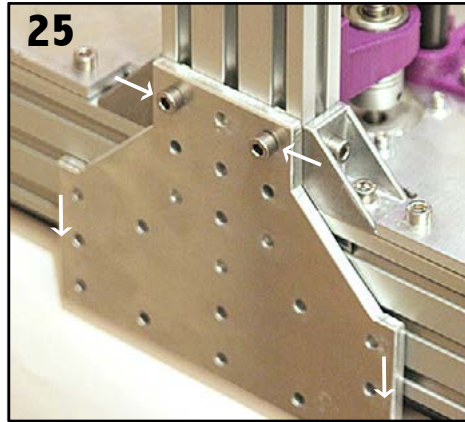
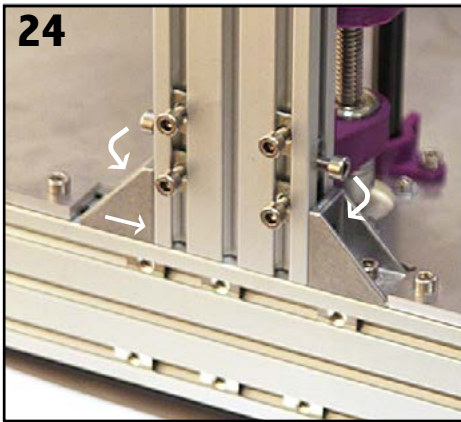



## Final assembly

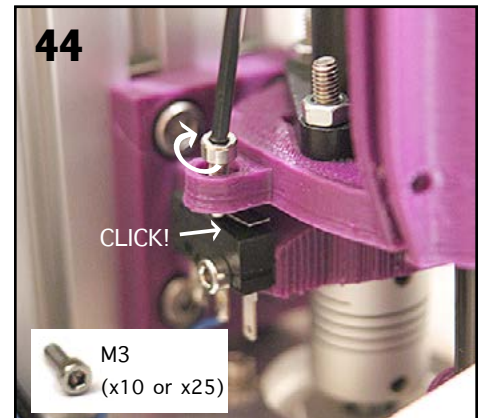
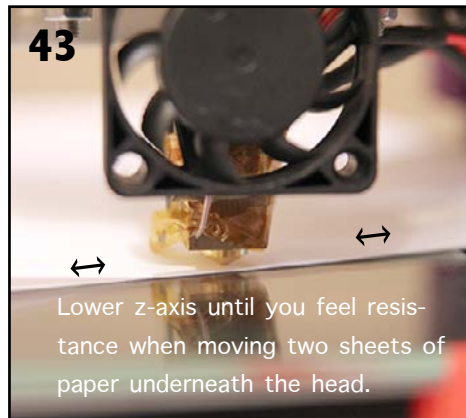
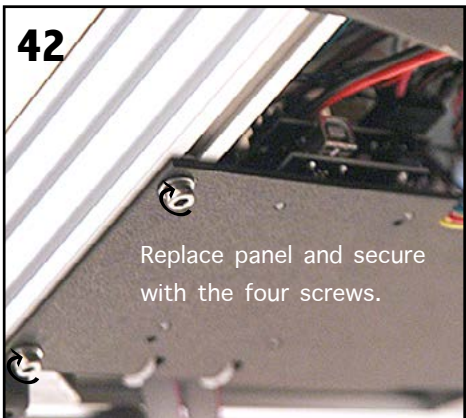
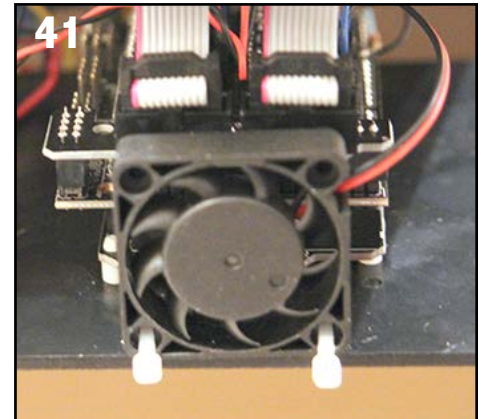
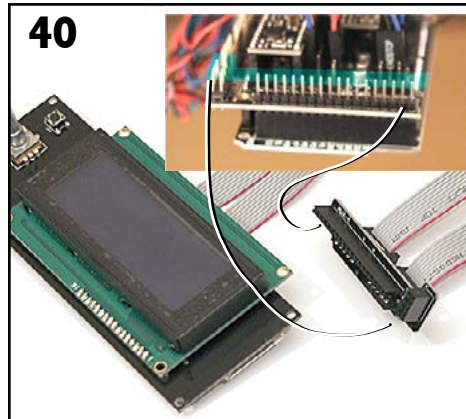
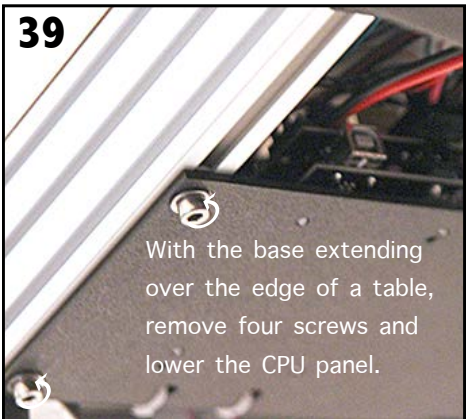
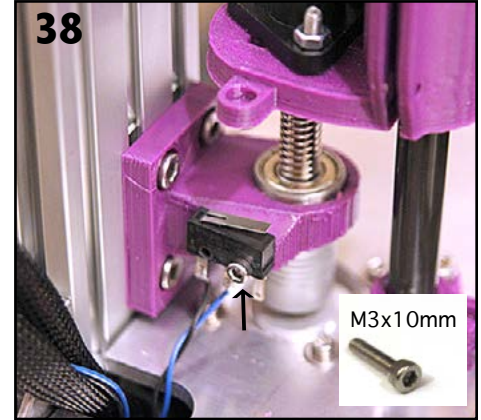
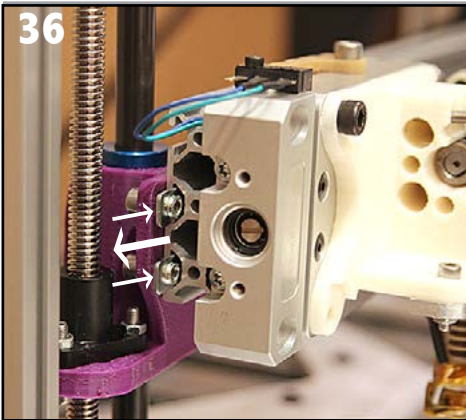

**45**

Download and load config.ini files into Slic3r or other slicing program. For example:  
<https://gist.github.com/ezmobius> has settings for hollow and structural infill objects.

**46** A good first print is a 20mm cube, like the one on thingiverse:  
<http://www.thingiverse.com/thing:34553>  
 Slice it, then copy the file (like 20mmcube.gcode) to an SD card and insert it into the LCD controller, preheat the bed, and choose the gcode file from the card menu.

